

ST 060 400 3811

- senza contrassegno
- diametro foro piletta 32 mm
- senza rosetta
- manopola Ø 60mm



	platinato / platinato opaco	ST 060 400 3811-36
	Cromato	ST 060 400 3811-00
	Platinato spazzolato	ST 060 400 3811-06
	Dark Chrome	ST 060 400 3811-19
	Ottone spazzolato (Oro 23k)	ST 060 400 3811-28
	Ottone / Ottone spazzolato (Oro 23k)	ST 060 400 3811-38
	Dark Platinum spazzolato	ST 060 400 3811-99

**Componenti singoli di questo set**

Per questo set sono necessari i seguenti componenti

1x 11 187 811-06



1x 20 000 811-36











ST 060 400 3811

- senza contrassegno



	Platinato spazzolato	11 187 811-06
	Cromato	11 187 811-00
	Platinato	11 187 811-08
	Ottone (Oro 23k)	11 187 811-09
	Dark Chrome	11 187 811-19
	Ottone spazzolato (Oro 23k)	11 187 811-28
	Dark Platinum spazzolato	11 187 811-99

ST 060 400 3811

mm [inches]

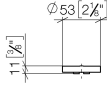

ST 060 400 3811

Parts for other  
finishes can be found  
here: Cromato

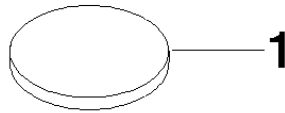

- diametro foro piletta 32 mm
- senza rosetta
- manopola Ø 60mm

ATTENZIONE: Gli inserti maniglia devono essere ordinati separatamente per i raccordi!

	platinato / platinato opaco	20 000 811-36
	Cromato	20 000 811-00
	Platinato spazzolato	20 000 811-06
	Dark Chrome	20 000 811-19
	Ottone spazzolato (Oro 23k)	20 000 811-28
	Ottone / Ottone spazzolato (Oro 23k)	20 000 811-38
	Dark Platinum spazzolato	20 000 811-99



ST 060 400 3811

mm [inches]

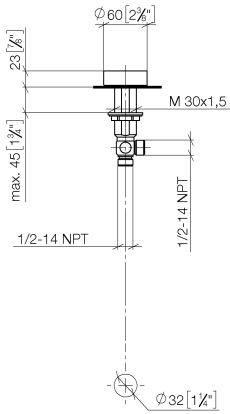

Certificati

LGA\_38120.

IAPMO\_N-4976.

IAPMO\_6397.

WRAS\_2109021.

ST 060 400 3811

Parts for other  
finishes can be found  
here: Cromato

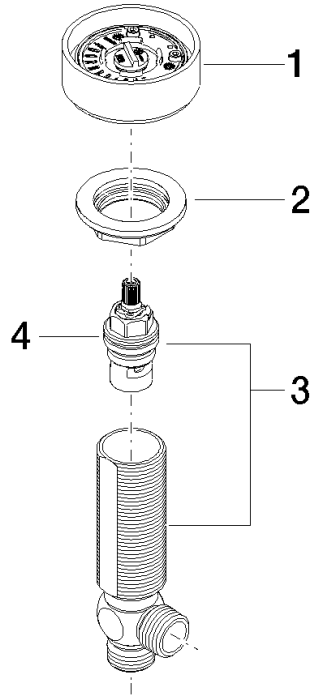

### Elenco delle parti di ricambio

N.	Codice articolo	Denominazione	Quantità necessaria	Tempo di produzione
1	90 18 40 291 01-36	manopola	1	20
2	04 30 11 038 68 90	set di fissaggio	1	2
3	04 17 11 055 61 90	parte laterale	1	2
4	90 90 03 237 00 90	parte superiore	1	2